

UNO-2372G

Intel Atom/Celeron Small-Size Modular Box Platform with 2 GbE, 4 USB, 4 COM, 2 mPCIe, HDMI, DP

NEW



UNO-2372G-E021AE

UNO-2372G-E022AE



Features

- Intel Atom E3845/Celeron® J1900 Quad-Core processors with 4G DDR3L memory
- Robust and cableless design with high stability
- 2 x GbE, 4 x USB, 4 x RS-232/422/485, 1 x HDMI, 1 x DP
- Modular design with flexibility to extend second stack for function enhancement
- Compact size with fanless design
- Rubber stopper design for stand mount and optional kit for DIN-rail mount, and VESA mount
- Optional 3G/GPS/GPRS/Wi-Fi communication

Introduction

Advantech's new generation UNO-2000 series of Embedded Automation Computers are a highly ruggedized fanless and modular design. The incredible modularity of UNO-2372G offers numerous performance and cost-saving advantages, including elimination of unnecessary features and expenses, accelerated production and delivery, rapid deployment and integration, reduced system downtime and maintenance costs, and support for future upgrades and expansion. The UNO-2372G's modular design features optimized I/O and an optional second expansion stack that support Advantech's iDoor technology. This allows the platform functionalities to be easily extended and customized with the integration of various iDoor modules, including industrial Fieldbus, wireless communication, I/O and peripheral module, to provide purpose-built, future-proof solutions that satisfy specific application requirements.

Specifications

General

- Certification** CE, FCC, UL, CCC, BSMI
- Dimensions (W x D x H)** Single stack: 150 x 105 x 35mm
Double Stack: 150 x 105 x 65mm
- Form Factor** Small Size
- Enclosure** Aluminum Housing
- Mounting** Stand, Wall, VESA (Optional), DIN-rail (Optional)
- Weight (Net)** 1.0kg (2.2lbs)
- Power Requirement** 10 - 36V_{dc}
- Power Consumption** 30W (Typical), 42W (Max)
- OS Support** Microsoft® Windows 7, Windows 10, Advantech Linux

System Hardware

- BIOS** AMI UEFI64 Mbit
- Watchdog Timer** Programmable 255 levels timer interval, from 1 to 255 sec
- Hardware Security** TPM2.0 (UNO-2372G-J Series)
- Processor** Intel® Atom Quad Core E3845 1.91GHz / Intel® Celeron® Quad Core J1900, 2GHz
Built-in 4GB DDR3L 1333MHz (Up to 8GB)
- Memory** Intel HD Graphics
- Graphics Engine** Intel® i210-IT GbE, 802.1Qav, 802.1AS, 802.3az
- Ethernet** LEDs for Power, RTC battery, LAN (Active, Status) and HDD
- LED Indicators**
- Storage** 1 x mSATA shared with mPCIe slot
1 x drive bay for SATA 2.5" HDD (Compatible with 9.5mm height HDD)
- Expansion** 2 x Full size mPCIe slots

I/O Interfaces

- Serial Ports** 4 x RS232/422/485, DB9, 50 ~ 115.2kbps
- LAN Ports** 2 x RJ45, 10/100/1000 Mbps IEEE 802.3u
1000BASE-T Fast Ethernet
- USB Ports** 1 x USB 3.0, 3 x USB 2.0 Compliant
- Displays** 1 x HDMI 1.4 (1920x1080@60Hz)
1 x DP 1.1 (2560x1600@60Hz)
- Power Connector** 1 x 2 Pins, Terminal Block

Environment

- Operating Temperature** -20 ~ 60°C (-4 ~ 140°F) @ 5 ~ 85% RH with 0.7m/s airflow
- Storage Temperature** -40 ~ 85°C (-40 ~ 185°F)
- Relative Humidity** 10 ~ 95% RH @ 40°C, non-condensing
- Shock Protection** Operating, IEC 60068-2-27, 50G, half sine, 11ms
- Vibration Protection** Operating, IEC 60068-2-64, 2Grms, random, 5 ~ 500Hz, 1hr/axis (mSATA)
Operating, IEC 60068-2-64, 0.75Grms, random, 5 ~ 500Hz, 1hr/axis (HDD)
- Ingress Protection** IP40

Installation Scenario

DIN-rail Mount Illustration

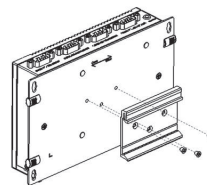

VESA Mount Illustration

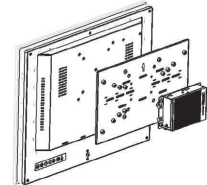

Ordering Information

- UNO-2372G-E021AE** Intel Atom E3845 1.91GHz, 4GB, 2 x GbE, 2 x mPCIe, HDMI/DP (Single Stack)
- UNO-2372G-E022AE** Intel Atom E3845 1.91GHz, 4GB, 2 x GbE, 2 x mPCIe, HDMI/DP (Dual Stack for iDOOR expansion)
- UNO-2372G-J021AE** Intel Celeron J1900 2.0GHz, 4GB, 2 x GbE, 2 x mPCIe, HDMI/DP (Single Stack)
- UNO-2372G-J022AE** Intel Celeron J1900 2.0GHz, 4GB, 2 x GbE, 2 x mPCIe, HDMI/DP (Dual Stack for iDOOR expansion)

Dimensions

Single Stack

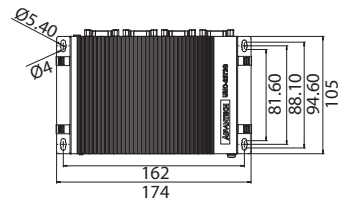

Unit: mm

Dual Stack

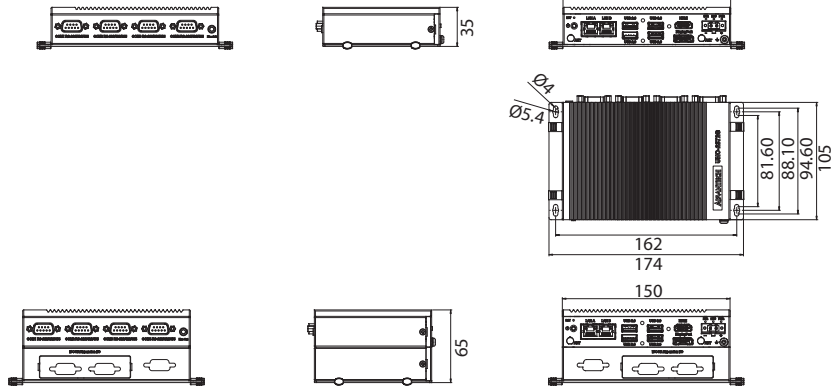

Front I/O View

Single Stack

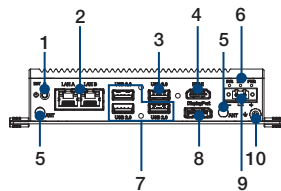

Dual Stack

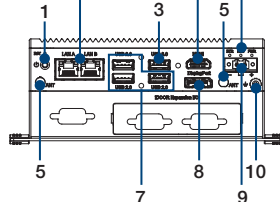

- | | |
|---------------------|------------------------------|
| 1. Power Button | 6. BTR, HDD & PWR LED Lights |
| 2. RJ45 LAN | 7. USB 2.0 |
| 3. USB 3.0 | 8. DisplayPort |
| 4. HDMI | 9. Power Connector |
| 5. Reserved Antenna | 10. Chassis Grounding |

Rear I/O View

Single Stack

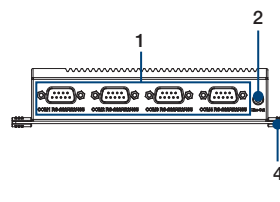

Dual Stack

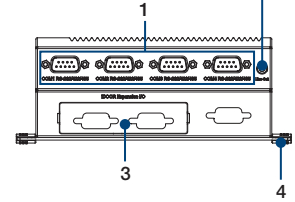

- | | |
|-------------------|-------------------------|
| 1. RS-232/422/485 | 3. iDoor Expansion Slot |
| 2. Line Out | 4. Rubber Stopper |

iDoor Modules

iDoor modules are supported by UNO-2372G-E022AE & UNO-2372G-J022AE. (UNO-2372G-E021AE & UNO-2372G-J021AE can also support iDoor modules by adding 2nd stack extension kit UNO-2372G-EKBE)

- **PCM-24D2R2-BE** 2-Port Isolated RS-232 mPCIe, DB9
- **PCM-24D2R4-BE** 2-Port Isolated RS-422/485 mPCIe, DB9
- **PCM-24D4R2-BE** 4-Port Non-Isolated RS-232 mPCIe, DB37
- **PCM-24D4R4-BE** 4-Port Non-Isolated RS-422/485 mPCIe, DB37
- **PCM-26D2CA-AE** 2-Port Isolated CANBus mPCIe, CANopen, DB9
- **PCM-27D24DI-AE** 24-Channel Isolated Digital I/O w/ counter mPCIe, DB37
- **PCM-24R1TP-AE** 1-Port Gigabit Ethernet, Intel® 82574L, mPCIe, RJ45
- **PCM-24S2WF-BE** WiFi 802.11 ac/a/b/g/n 2T2R w/Bluetooth 4.1
- **PCM-24S33G-AE** Wide-Temp 3.75G HSPA and GPS, 2-in-1, Full-size mPCIe w/ Redundant SIM Card holder, 2-port SMA

Contact Advantech for more compatible iDoor solutions

Optional Accessories

- **96PSA-A60W24T2** A/D 100-240V 60W 24V C14 Cord End Terminal Power Adapter
- **1702002600** Power Cable US Plug 1.8 M (Industrial Grade)
- **1702002605** Power Cable EU Plug 1.8 M (Industrial Grade)
- **1702031801** Power Cable UK Plug 1.8 M (Industrial Grade)
- **1700000596** Power Cable China/Australia Plug 1.8 M (Industrial Grade)
- **UNO-2000G-DMKAE** UNO-2000 DIN Rail Kit
- **UNO-2000G-VMKAE** UNO-2000 VESA Mount Kit
- **UNO-2000-LKAE** Cable lockable kit 10 units/per pack
- **UNO-2372G-VEGA330** UNO-2372G 1st stack bottom plate for VEGA-330

Embedded OS

UNO-2372G-E0xxAE

- **20703WE7PS0002** WS7P X64 MUI V4.18 B007 image
- **20703WX6ES0003** WIN10ENT 2016LTSC v6.02B016 image
- **20703WX9ES0005** WIN10 2019 LTSC v6.04 B014 image

UNO-2372G-J0xxAE

- **20703WX6ES0003** WIN10LTSC v6.02 B016 image
- **20703WC70S0034** WEC7 MUI V4.02 B116 image
- **20703WE7PS0019** WS7P x64 MUI V4.19 B009 image
- **20703WX9ES0005** WIN10 2019 LTSC v6.04 B014 image

Please note: If some optional modules are offered with the system, additional system certificates may be required in certain regions/countries. Please contact Advantech for certificate compliance.